



# Greenhouse in the Snow



# Table of Contents

<b>1</b>	Contact Information
<b>2</b>	Greenhouse in the Snow Kit
<b>5</b>	Automatic Vent System
<b>7</b>	Evaporative Cooling Wall
<b>8</b>	Retaining Wall Planters
<b>9</b>	Single Wall Planter
<b>10</b>	Liquid-to-Air Geothermal System
<b>12</b>	Blower Box
<b>13</b>	Engineered Retaining Wall Sets
<b>14</b>	Wind Kit
<b>15</b>	Winter/Summer Thermostat
<b>16</b>	Horizontal Air Flow Fan



# Table of Contents

- 17** 25 mil Polycarbonate
- 18** 8 mil Polycarbonate
- 19** Blower w/Motor Assembly
- 20** Single Stage Thermostat



# Greenhouse in the Snow

## Contact Information



Greenhouse in the Snow  
1114 West 2nd St.  
Alliance, NE 69301



308-760-9718



[info@greenhouseinthesnow.com](mailto:info@greenhouseinthesnow.com)



[www.greenhouseinthesnow.com](http://www.greenhouseinthesnow.com)



Come see us in person!  
Book a tour of the  
greenhouse via our  
website or give us a call  
and schedule today! It is  
definitely worth the visit :)



# Greenhouse in the Snow

## Geothermal Greenhouse Kit

### Geothermal Greenhouse Kit



All kits are 17' wide & galvanized



The smallest kit offered is 36' long & we increase in 6' increments in length



96' and 102' long are the most efficient sizes



**36' - 48' @ \$249/lin. ft**

**54' - 150' @ \$197/lin. ft**



**Note:  
36' - 48'  
will only  
be sold  
with  
Liquid to  
Air  
Systems  
ONLY!**



**Cheaper** than sourcing the same size of conventional greenhouse **PLUS** the added bonus of heating/cooling efficiency and **YEAR-ROUND** growing ability!



**Kits contain:**

- the complete metal frame
- polycarbonate sheeting
- all screws/washers & joints/plates to put it together
- a complete step-by-step guide
- unlimited tech support via phone & email
- a materials list of the items you need to purchase locally to finish your greenhouse build



The kit does not include the blowers with motors and thermostats for the air-to-air system tubes, **HOWEVER** we do keep them in stock, and they are available for purchase as an option on the greenhouse kit.

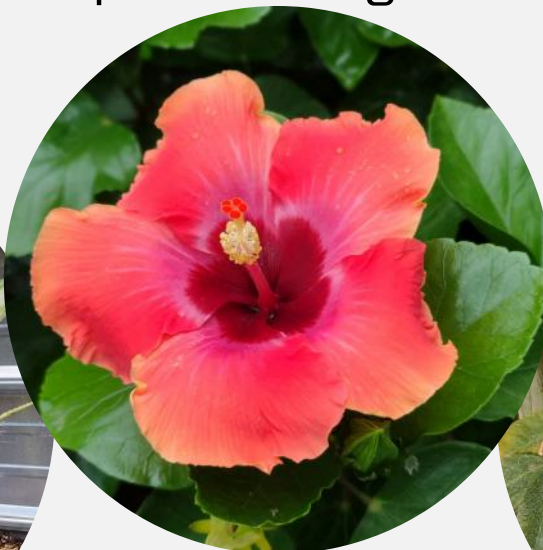



**Greenhouse in  
the Snow**

Alliance, NE ~ **308-760-9718**  
[greenhouseinthesnow.com](http://greenhouseinthesnow.com)  
**Sustainable food supply.  
Sustainable life.**



We also provide a **materials list** of items that **you need to purchase locally** like tubes, doors, etc. This list is available upon request before purchase and is also in the step-by-step guide.



Blowers with motors & thermostats, freight and many other options are offered with the greenhouse kits for additional costs.

**Contact us today to request your quote!**

**You can request via email at:**

**[info@greenhouseinthesnow.com](mailto:info@greenhouseinthesnow.com)**

**Via phone at **308-760-9718****

**Or on our website at:**

**[www.greenhouseinthesnow.com/request-a-quote](http://www.greenhouseinthesnow.com/request-a-quote)**

View a DEMO at <https://photos.app.goo.gl/cu1y1n5GbscRzyZ36>

# Automatic Vent System

## Automatic Vent System (2 vents/system)



One vent on each end of greenhouse



Controlled by thermostat (wifi compatible) to automatically open and shut as needed & comes with all controls



Pan is not flat, so it sheds water

# \$5,371.12\*

\*NOTE: Does not include shipping. Shipping is calculated at time of shipment.

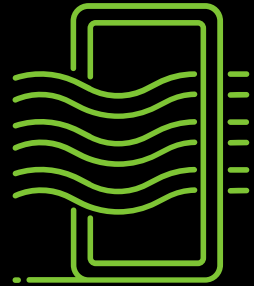

\*Prices Subject to Change at Any Time





If purchasing an evaporative cooling system AND automatic vent, you will need a large fan to place in the automatic vent due to not being able to put the ventilation fans in the wall like normal.



Pricing for the 42" fan is below plus the adapter kit for placing it in the vent.

**\$1,604.06\***

**fan**

**+**

**\$250\***

**adapter  
kit**

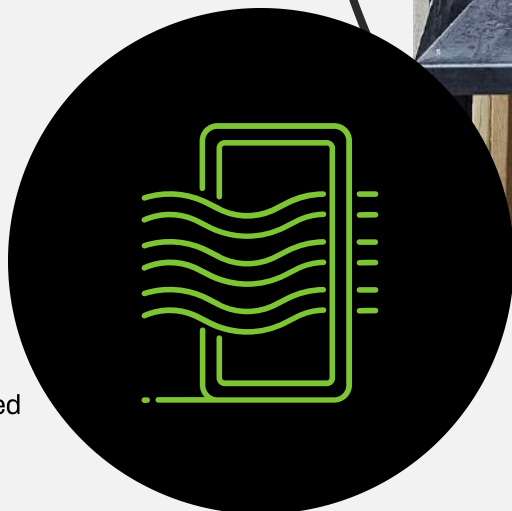
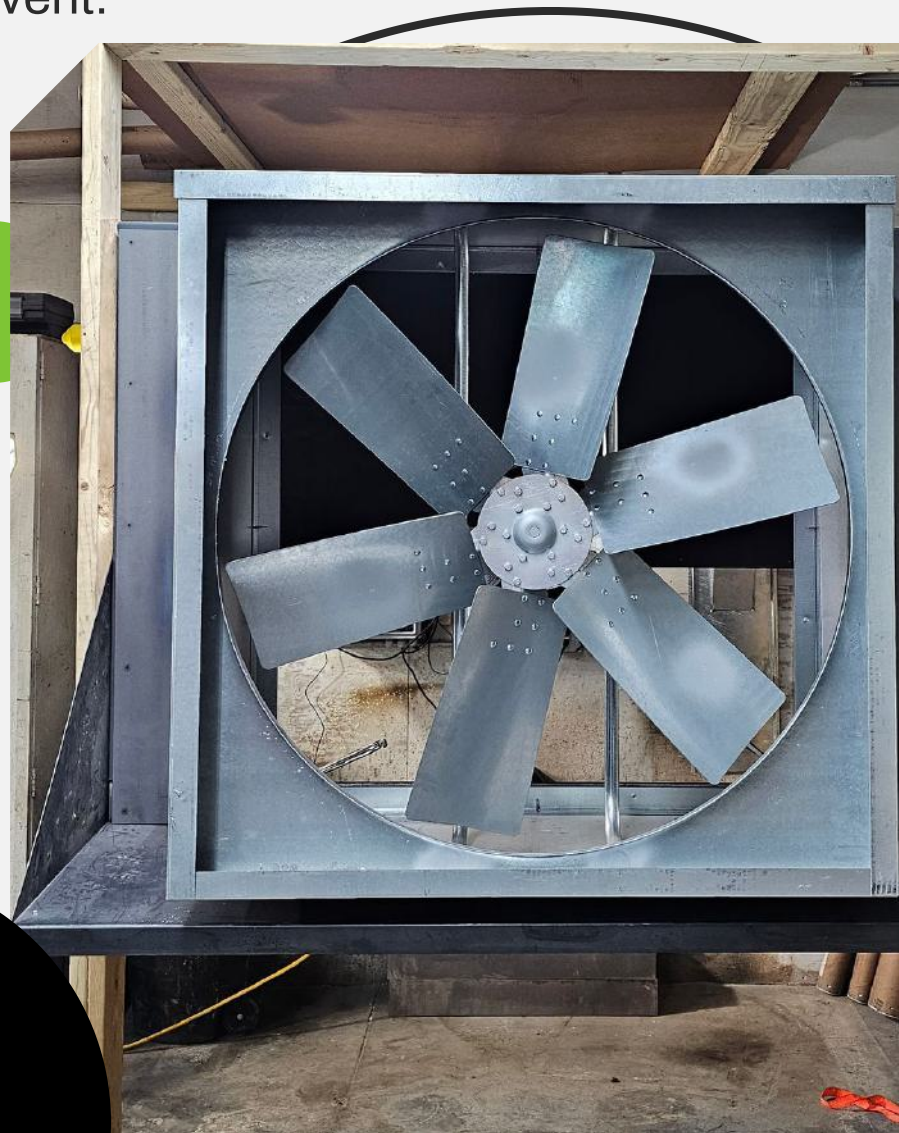

\*NOTE: Does not include shipping. Shipping is calculated at time of shipment.

\*Prices Subject to Change at Any Time

# Evaporative Cooling Wall

**Price  
includes  
shipping!**

## Evaporative Cooling Wall



Uses combination of air, water, and evaporation to add cool, humid air to the greenhouse environment



Ships straight from manufacturer



The heat of the greenhouse is used to evaporate water, turning it into vapor and assisting in cooling the greenhouse

**\$3,199.75**



\*Prices Subject to Change at Any Time

# Retaining Wall Planters

## Retaining Wall Planters



Extra growing space - great for smaller plants



Awesome for planting pollinator attractants



Add many or few to your retaining wall



Made out of galvanized steel



Even use them by themselves as raised growing beds - inside or outside the greenhouse!



# \$75.12/strip

Note: Does not include shipping.

\*Prices Subject to Change at Any Time



# Single Wall Planter

## Single Wall Planter



Extra growing space - great for smaller plants



Awesome for planting pollinator attractants



Add anywhere to your retaining wall!



Made out of galvanized steel



Attach inside or even outside of your greenhouse!



# \$26.99

Note: Does not include shipping.

\*Prices Subject to Change at Any Time



# Geothermal Exchange System

## Liquid-to-Air

### **Liquid-to-Air Geothermal System - instead of Air-to-Air Tubes (Field Drainage Tiles)**



Operate geothermally despite high water tables



Smaller trenches than the air-to-air tube system



Closed-loop, utilizing nontoxic antifreeze, circulating it through to a heat exchanger



---

**\$5,065.78**



For **36' - 48'** long greenhouses

---

**\$5,680.29**

For **54' - 84'** long greenhouses



---

**\$6,566.66**



For **90' - 126'** long greenhouses

---

**\$7,372.22**

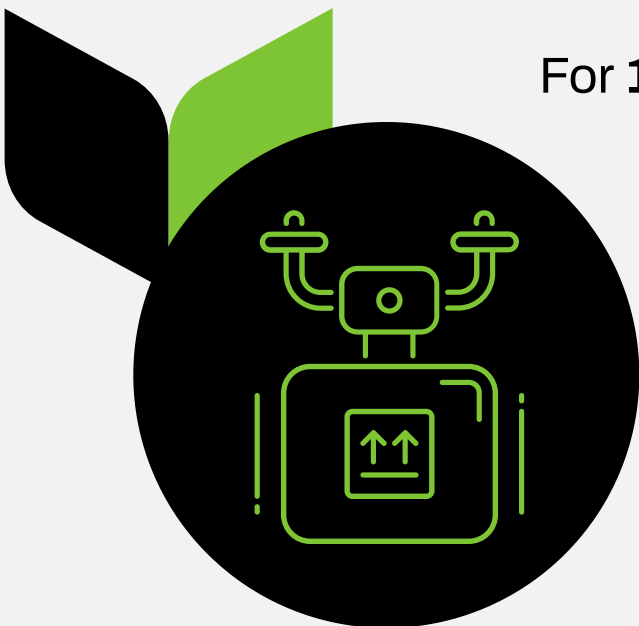

For **132' - 150'** long greenhouses



**Price  
includes  
shipping!**

# Blower Box for Squirrel Cage Blowers

## Blower Box

-  DIY assembly kit for a finished box to enclose your squirrel cage blowers
-  Galvanized finishing
-  Complete with screws & instructions

**\$378/box\***

**Price  
includes  
shipping!**

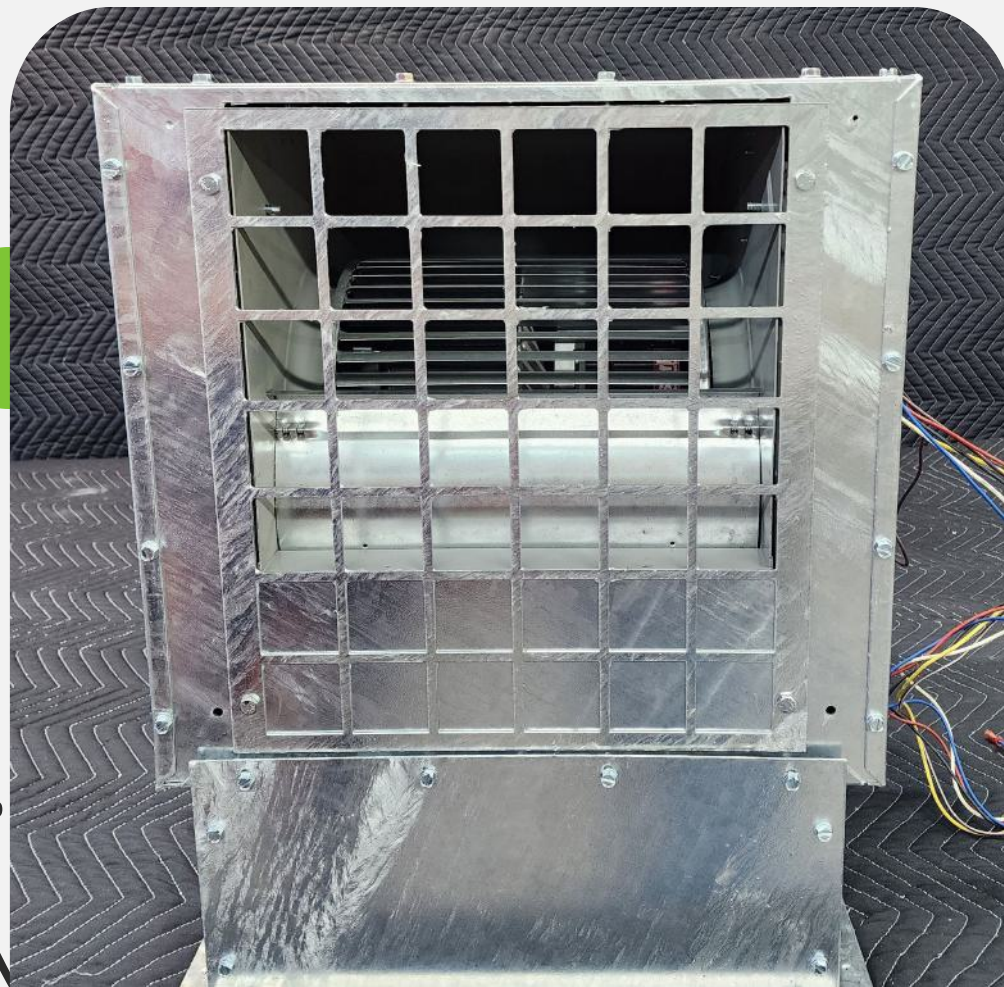

\*Prices  
Subject to  
Change  
at Any  
Time

# Cross Members & Attachments for **Engineered Retaining Wall**

## Engineered Retaining Wall Sets



Set includes cross member & two hangers to attach them to retaining wall posts



Galvanized Steel



Composite and wood posts (as pictured) are not included

**\$132.25/set\***

\*NOTE: Does not include shipping. Shipping is calculated at time of shipment.

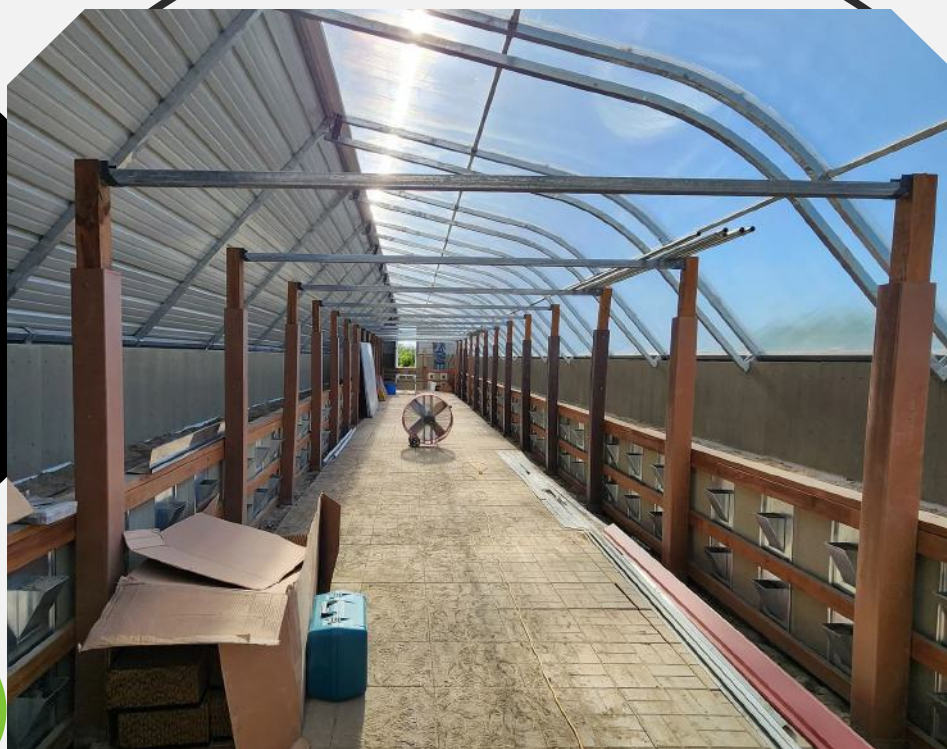

\*Prices Subject to  
Change at Any Time



# Lexan Wind Kit



## Lexan Wind Kit



Utilize for areas with extreme high wind



Extra stability for polycarbonate sheeting

**\$11.13/plate\***

Note: Does not include shipping



\*Prices Subject to  
Change at  
Any Time



# Winter/Summer Thermostat with Switch

## Winter/Summer Thermostat with Switch



Thermostat for the heating/cooling tubes



Allows for the running of heating and cooling on **ONE** thermostat instead of **TWO**

**\$110\***

\*NOTE: Does not include shipping.



\*Prices Subject to Change  
at Any Time



# Horizontal **Air Flow Fans**

## Horizontal Air Flow Fans



Ideal for pushing air through the greenhouse



Keeps air flowing through the greenhouse efficiently, especially longer greenhouses

**\$153**

\*NOTE: Does not include shipping.

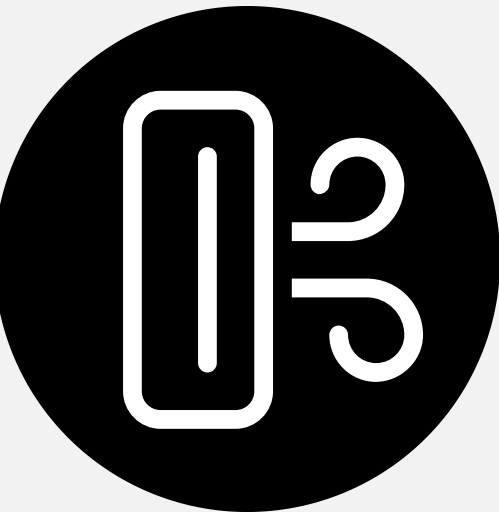

\*Prices Subject to Change  
at Any Time



# Polycarbonate Sheeting

## 25 mil - Triplewall

### Polycarbonate - 25 mil



25 mil thick (0.98") @ 4' x 12' sheets



UV treated on 1 side



Heavy-duty roof panels used for things like conventional greenhouse coverings



In-Stock in Denver & Alliance for shipping/pickup

# \$350/sheet\*

\*NOTE: Does not include shipping.

Shipping is calculated at time of shipment.





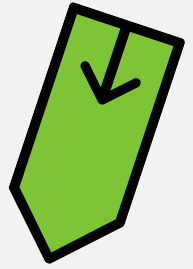

\*Prices  
Subject to  
Change  
at Any  
Time

# Polycarbonate Sheeting 8 mil - Twinwall



## Polycarbonate - 8 mil

-  8 mil thick @ 14' x 71.25" sheets
-  UV treated on 1 side
-  Heavy roof panels used for our geothermal, free-standing, and lean-to greenhouses
-  In-Stock in Denver & Alliance for shipping/pickup

**Note to Current Greenhouse Customers:**  
Please reach out to us for special pricing!



# \$307/sheet\*

\*NOTE: Does not include shipping.  
 Shipping is calculated at time of shipment.

\*Prices Subject to Change at Any Time





# Squirrel Cage Blower w/Motor Assembly

**Price  
includes  
shipping!**

## Blower w/Motor Assembly



(See diagram)

Measurements: K (13-1/16"), E (11-3/8"), A (18-7/8"), B (16-1/2")



Assembled w/motor - 1/2 HP, 115V



Utilized on the heating or cooling geothermal tubes in the greenhouse

**\$844.99**

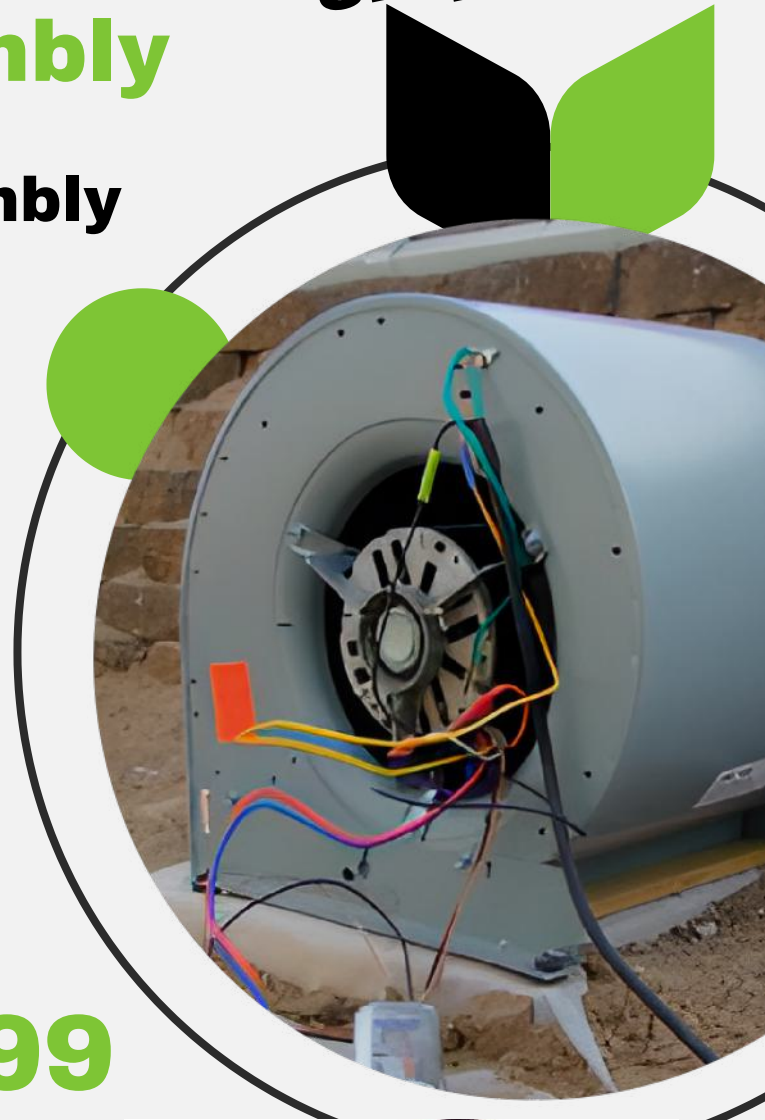

**Note to Current  
Greenhouse  
Customers:**



Please reach out to us  
for special pricing!

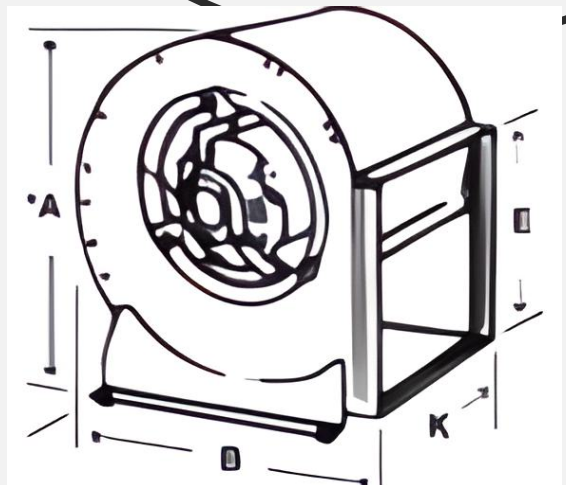

\*Prices Subject to Change at Any Time

# Single Stage Weatherproof Thermostat

## Thermostat



Thermostat utilized for heating & cooling tubes in our geothermal greenhouses



Single stage, 120V, w/8' piggyback plug-in, Made in USA



Adjust from 30 to 110 degrees Fahrenheit



Great for greenhouses, barns, livestock buildings, & more!

**\$89\***

\*NOTE: Does not include shipping.

\*Prices Subject to Change  
at Any Time

